



GRANITE *Elite*® — MILITARY PERSONNEL CARRIER

BUILT LIKE A MACK TRUCK®



TECHNICAL SPECIFICATIONS— GRANITE ELITE® GU813E

Transport Type/ Application:	Truck, Class C Heavy Vocational	Fan Drive:	Behr electronic modulating
Engine:	13 Liter, MP8 400 Maxicruise 400HP (298kW), 1460lb/ft torque (1979Nm) Mack Powerleash Engine Brake V-MAC IV Electronics System Pedigreed Protection Plan	Electronics:	V-MAC IV engine protection system Body-link II interface
Wheel Configuration:	6X4	Air System:	Meritor/Wabco air dryer
Fuel Capacity:	Left side- 116 gal (439L), 22" (56cm) diameter steel Right side- 116 gal (439L), 22" (56cm) diameter steel	Mirrors (side):	Aerodynamic body colored, heated, motorized
Driveline	Meritor Heavy Duty	Lighting:	Halogen flush headlights Flasher type signal lights Body marker lights
Transmission/ Clutch:	Eaton-Fuller FRO-15210C, 10 speed manual with overdrive (2 reverse speeds) Eaton-Fuller CL7981, 15.5" (39.4cm), manual adjust	Starter:	12V, Gear reduction
Brake System:	Meritor "S" Cam Q-Plus 16.5x6 Cam-front, 16.5x7 Cam-rear Bendix 4S/4M ABS System	Batteries (3):	Mack 12V, 1950 cold cranking amps (CCA)
Front Axle/ Suspension:	Mack FXL18 (wide pivot center) 18,000lb (8,165kg) rating Taperleaf spring suspension, axle-back position	Alternator:	12V, Delco, 100A
Rear Axles/ Suspension:	Mack S462, 46,000 lb (20,865kg) rating 5.02 carrier ratio Multileaf Camelback tandem suspension	Cab Interior:	4 dome lights, dual auxiliary power outlets, 3 overhead storage bins with netting
Frame:	11.1mm x 300mm x 90mm Steel frame rails 236" (599.4cm) wheelbase 256" (650.2cm) platform 86" (218.4cm) overhang	Air Compressor/ Air Cleaner :	Meritor/Wabco 318cc (18.7cfm) (8.9L/s) 11" (28cm) Donaldson single element, steel
Driver Seat:	Bostrom Talladega 9215 (air suspension)	Paint:	Chassis- heavy-duty urethane base coat Cab exterior- urethane base coat
Passenger Seat:	Mack Fixed (mid-back)	GVW:	64,000lbs (29,030kg)
		Front/Rear Tires:	Bridgestone M860, 315/80R22.5 (all position)
		Towing Capacity:	30 ton (27.2 tonne) pintle hook with mounting hooks and safety chains
		General Body Specifications:	Seating for 42 in carrier (12 on each side, 18 in middle) Steel tread plate floor with 6 D-ring tie downs Single color tarp with 3 windows per side 72" (182.9cm) tarp clearance height Full carrier lighting Fold-down tailgate and sides with protective bumpers

CUSTOMIZED OPTIONS AVAILABLE TO MEET MISSION REQUIREMENTS



GRANITE *Elite*® — MILITARY PERSONNEL CARRIER

BUILT LIKE A MACK TRUCK®

STANDARD CARRIER FEATURES

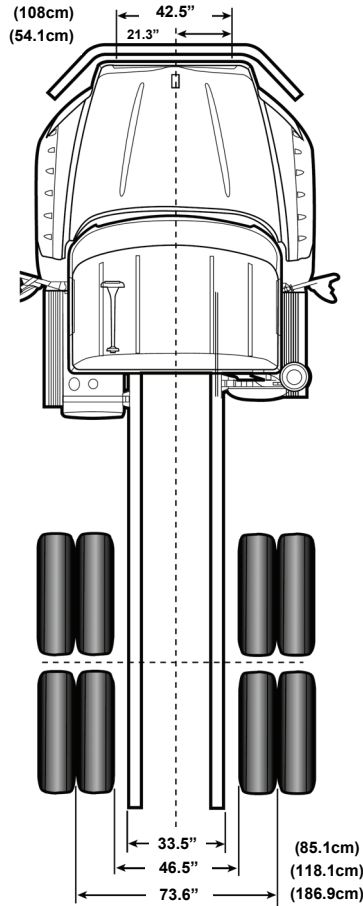
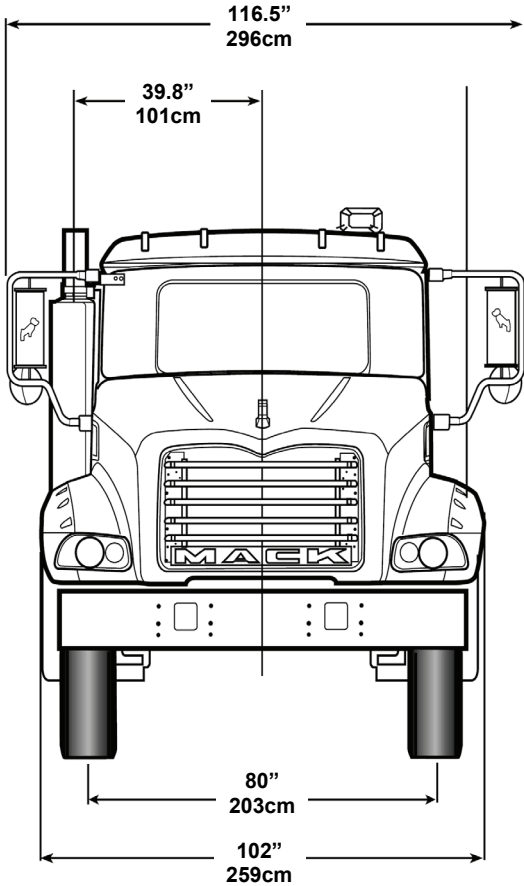

- 42 person seating capacity
- 4.76mm steel tread-plate floor
- 6 pairs of D-ring tie downs
- Folding/removable center seating row
- Folding sides and tailgate
- 27.2 tonne towing capacity
- Single color tarp with 3 windows per side and one in front
- 183cm clearance height from floor to top of tarp
- Full chassis paint with underbody rust coating

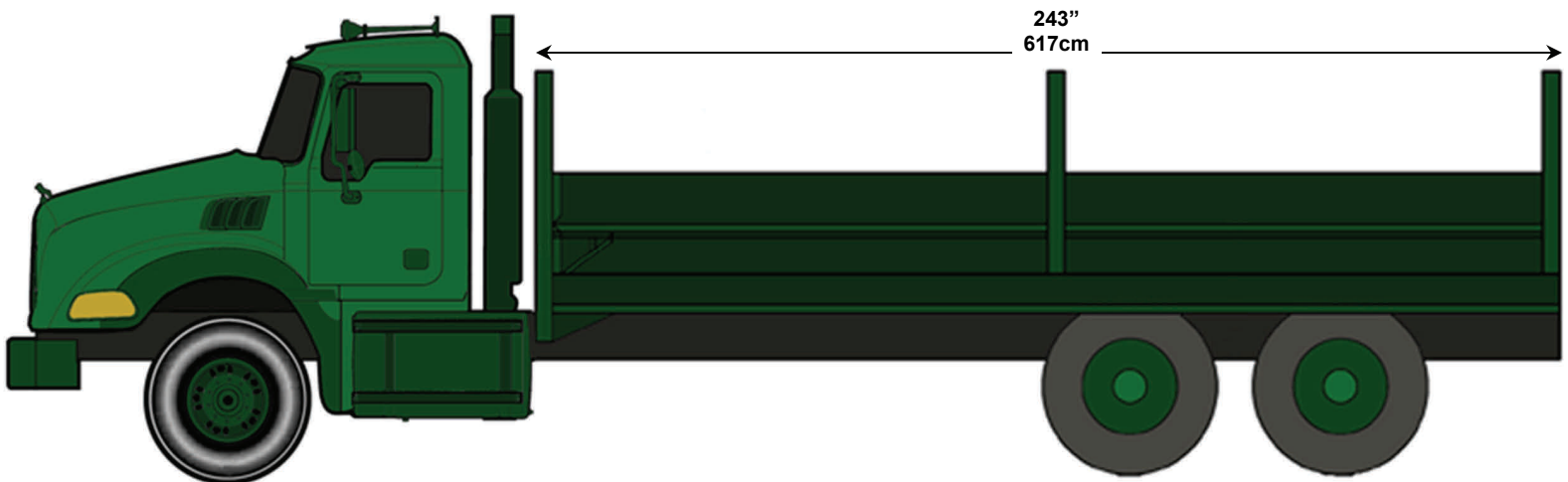
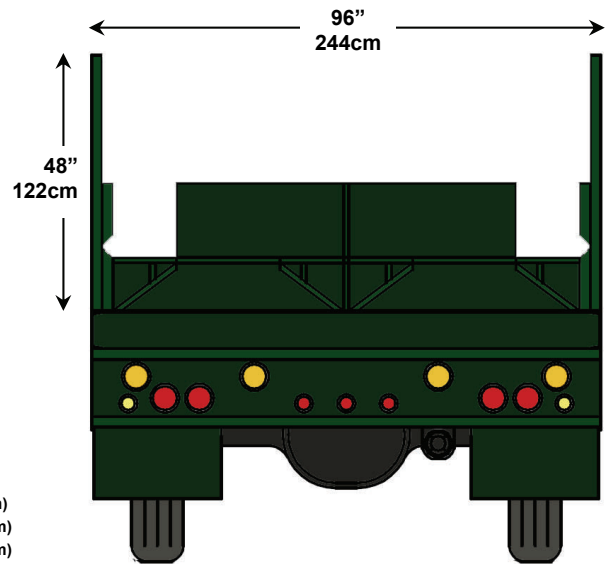

CUSTOMIZED OPTIONS AVAILABLE TO MEET MISSION REQUIREMENTS

For more information:

Mack Government/Military Office
 320 King Street, Suite 301
 Alexandria, VA 22314
 Tel: (703) 683-7010 Fax: (703) 548-1337
 MackMilitary@macktrucks.com



www.mackmilitary.com

©2009 Mack Trucks, Inc. All rights reserved.
 Mack, Mack and the Bulldog design, Granite,
 Taperleaf, and MP8, are trademarks of Mack
 Trucks, Inc. All other trademarks are the
 property of their respective companies.